



Satellite Signal Meter

VF-8922



USER'S MANUAL

FindSAT ~ The Best SAT Finder

Digital Satellite Finder provides a simple and convenient solution for setting up satellite dishes. Using the programmed satellite parameters, you can quickly, easily and accurately align any satellite dish.

1.Function

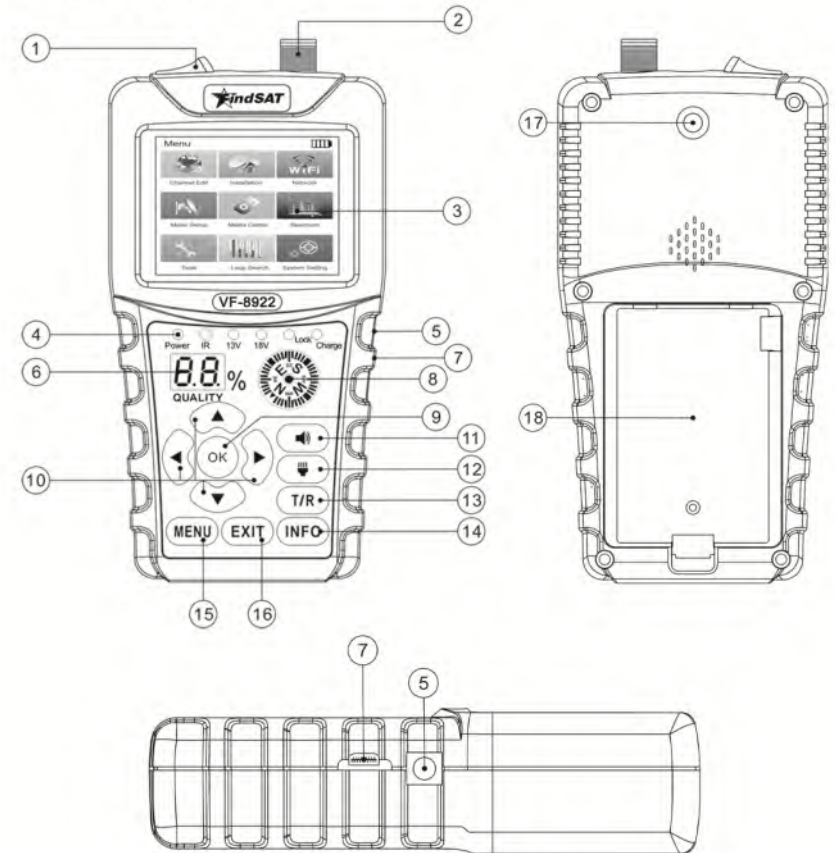

02 USER'S MANUAL

(1) Switch

(2) LNB Input

(3) LCD Screen

Displays satellite parameters and other technical.

(4) Working status indicator

①Power Light

Steady on: Power on state.

②IR

③13V 、 18V

Instructs the LNB to output the current working polarization voltage.

④Lock

Steady on: signal lock status

Blinking: Prompt user LNB output short circuit

⑤Charge Indicator

Light Slowly Flicker: Charging

Light Fast Flicker: Glitch

Steady Light : Fully charged

(5) DC input port

(6)Signal quality percentage display

03 USER'S MANUAL

(7) USB port

Can update SW/ TP/Satellites list

(8) Compass

(9) OK button

Confirm current operation

(10) Arrow keys

Up, down, left, and right buttons, press the button to move the cursor up, down, left, and right

(11) Hold down the key for 2 seconds to Beep

(12) Hold down the key for 2 seconds to Torch

(13) TV and radio switch

(14) Program information

(15) To show main menu

(16) To cancel selection or exit from current menu

(17) Lighting

(18) Battery cover

2 THE MENU OPERATION

- * Channel Edit
- * Installation
- * Network
- * Motor Setup
- * Media Center
- * Spectrum
- * Tools
- * Loop Search
- * System Setting

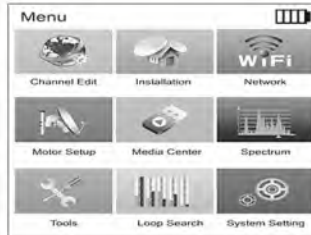

Press ▲/▼ ◀/▶ key to move the cursor, and use OK key to enter sub menu.

2.1 Channel Edit

* TV Channel

In the TV Channel Edit menu, you can press ◀/▶ key to select All TV or type TV like sport, education and so on. Press ▲/▼ key to high light channel, and press OK key to preview the desired TV channel.

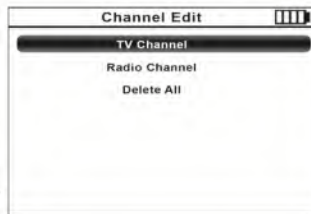
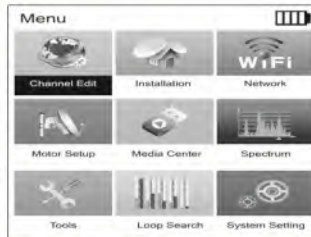

* Radio channel

In the Radio Channel Edit menu, the operation is similar to TV Channel Edit menu/ please refer to 3TV Channel.

* Delete All

Press OK, it will show up a warning message box to inquire you whether delete all or not.

If you select "Yes", all channels will be deleted.

If you select "No" or press EXIT, you can exit the function directly without save.

2.2 Installation

* Antenna Setting

Satellite: Press OK key to display satellite list, and use ▲/▼ key to move cursor, press OK key to confirm the setting.

LNB Frequency: Press OK key to display LNB frequency list, and use ▲/▼ key to move cursor, press OK key to confirm the setting.

22K: Press ◀/▶ key to switch 22K ON/OFF only under C-band frequency.

DiSEqC 1.0: Press OK key to display DiSEqC 1.0 port list, and use ▲/▼ key to move cursor, press OK key to confirm the setting.

TP: Press OK key to display transponder list, and use ▲/▼ key to move cursor, press OK key to confirm the setting.

Satellite Search: Press ◀/▶ key to switch scan mode first.

1. Satellite: Scan all transponder of the current satellite according to data base;

2. Blind: Scan all transponder of the current satellite;

3. TP: Only scan the current transponder;

4. Super Blind: Scan all transponder of the current satellite.

And press OK key to start searching.

* Satellite List

You can see the presorted satellite list in this menu, and press A key to choose the satellite which you want to use, also, you can delete/add/edit/search it according to the following tips.



SAT Name			Longitu	Directi
1	Nilesat	7.0	W	
2	Hotbird	13.0	E	
3	Badr 4/5/6/7K	26.0	E	
4	Thor 5/6/7	1.0	W	
5	Turksat 2A/3A	42.0	E	
6	BulgariaSat-1	2.0	E	
7	Eutelsat3B C	3.0	E	

Strength 53%

Quality 0%

Delete Add Edit Search
 All Antenna

06 USER'S MANUAL

* TP List

You can see the presorted transponder list of the current satellite in this menu, press ◀/▶ key to switch satellite, and press ▲/▼ key to choose the transponder which you want to use, also, you can delete/add/edit/search it according to the following tips.

2.3 Network

- Network Setting
- IPTV
- Weather
- Google Map
- Youtube
- Youporn
- Megogo
- Saavn

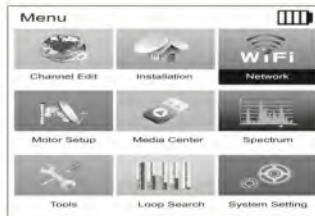

2.4 Motor Setup

Here you can set the antenna to fixed and motor.

Satellite: Press OK key to display satellite list, and use ▲/▼ key to move cursor, OK key to confirm the setting.

TP: Press OK key to display transponder list, and use ▲/▼ key to move cursor, OK key to confirm the setting.

Motor Type: Press ◀/▶ key to switch DiSEqC1.2/USALS

Save: Press OK to save the setting.

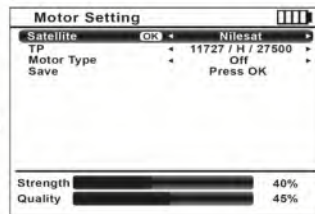
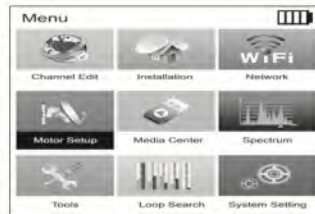

2.5 Media Center

Media Center will be disabled when no USB device is plugged.

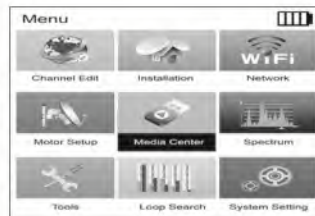

07 USER'S MANUAL

* File

USB can browse files within it, how to support files can be played directly in here, does not support file will be displayed in front of the "?".

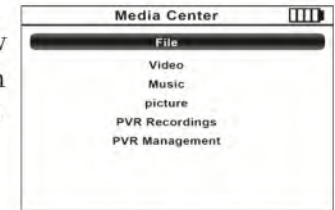

* Video

Video player supports a variety of formats such as: MP4, AVI, TS, MOV, MKV, MPG, etc.

* Music

Here you can set the Music information, slider to quickly select the location you want to play, songs can be single player, single cycle, the order of play, random play. currently only supports LRC format lyrics, LRC lyrics and the song of the same name needs.

* Picture

Support BMP/JPEG files can be auto matically carousel pictures.

2.6 Spectrum

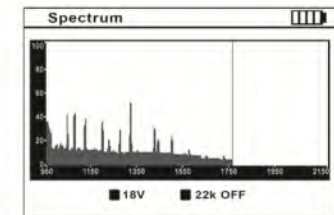
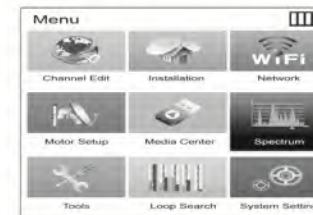

The spectrum shows that in the 950-2150 mid band, the over all condition of the signal is shown.

2.7 Tools

* Factory Reset

You can restore the product to the factory default and you can also setup it according to the wizard.

Warning: Please note that once you perform Factory Reset, all data and settings will be deleted.

* Software upgrade

Select USB Upgrade item and then press OK key to enter the following USB upgrade interface. If there is no USB device inserted, corresponding prompt will appear. Select the partition in which rom.bin is stored, then press OK key to enter a file

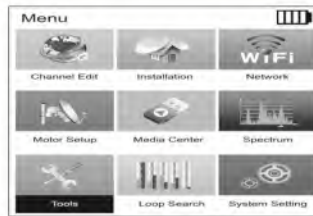

2.8 Loop Search

Group TP Freq search, TP Freq Edit.

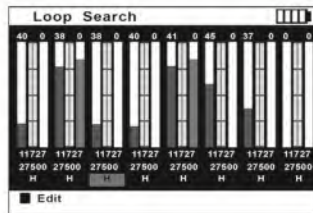
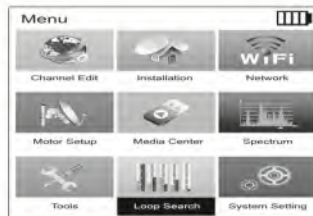

2.9 System Setting

* Time Setting

In Auto mode, you can set Time zone and Summer time; In Manual mode, you can set Date and Time.

* Language

In this menu, you can press ▲/▼ key to select the Menu Language, First Audio Language, Second Audio Language, Subtitle Language, TTX Language and EPG Language. Press Ok key to select your desired language.

* AV Setting

TV Standard: Press OK key to display video resolution list including 576i, 576p, 720p@50Hz, 720p@60Hz, 1080i@50Hz, 1080i@60Hz, 1080p@50Hz, 1080p@60Hz, and use ▲/▼ key to move cursor. Or, press OK key to confirm the setting.

TV Ratio: Press ◀/▶ key to switch 4:3/16:9.

Aspect Mode: Press ◀/▶ key to switch Auto/Letter Box/Pan & Scan.

Volume Scope: Press ◀/▶ key to switch Global/Channel.

Audio Descriptor: Press ◀/▶ key to switch ON/OFF.

* OSD Setting

Transparency: Press ◀/▶ key to change transparency from 0% to 60%.

OSD Timeout: Press ◀/▶ key to switch 3s/5s/7s.

Channel Switch: Press ◀/▶ key to switch Black/Freeze.

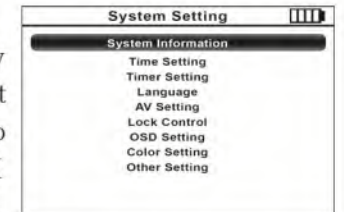

*** Color Setting**

Brightness: Press ◀/▶ key to change brightness from 20% to 100%.

Chroma: Press ◀/▶ key to change chroma from 20% to 100%.

Contrast: Press ◀/▶ key to change contrast from 20% to 100%.

3. Main Features

- * 2.4 inch LCD high resolution Screen (320*240) , Support Play TV program
- * 800M Hz based CPU,Flash Memory 64M Bits ,DDR3 SDRAM 512M Bits
- * Fully support DVB-S/DVB-S2,MPEG2/MPEG4 Compliant
- * Supports free switching between 2 different built-in UI styles
- * Spectrum Analyzer
- * Motor Set and antenna motor control --DiSEqC 1.2 /USALS/OFF
- * Support Unicable & work with SCR / DCSS LNB
- * With 2 kinds of Zoom
- * Support 2kinds of Loop Search
- * Support multiple OSD languages
- * Support DISEQC 1.0 / 1.1 / 1.2, USALS 0 / 22khz Tone
- * Support work with SCR , DCSS LNB
- * With Compass and Power Switch
- * Test Content: Signal Strength , Quality , BER, PWR, SNR ,etc
- * LNB short-circuit protection and indicator
- * Support low-voltage charging, can AUTO wake up the sleep Battery
- * Edit Transponder : Edit , Add and Delete
- * Audio alarm indicates signal intensity level
- * Signal lock audible notification: On/Off
- * Power-supply: 12V, 2A
- * With 2500mAh Fast charging big Li-ion battery , Ultra-long standby, low power consumption
- * With LED high brightness Torch
- * With Backlit Keys (On/Off)
- * With rubber protective cover
- * SW update by USB or Net upgrade



FindSAT bring
more professional
SAT Finder